

*Cambridge*  
*Art. Nr. 2848702*  
*1/8*

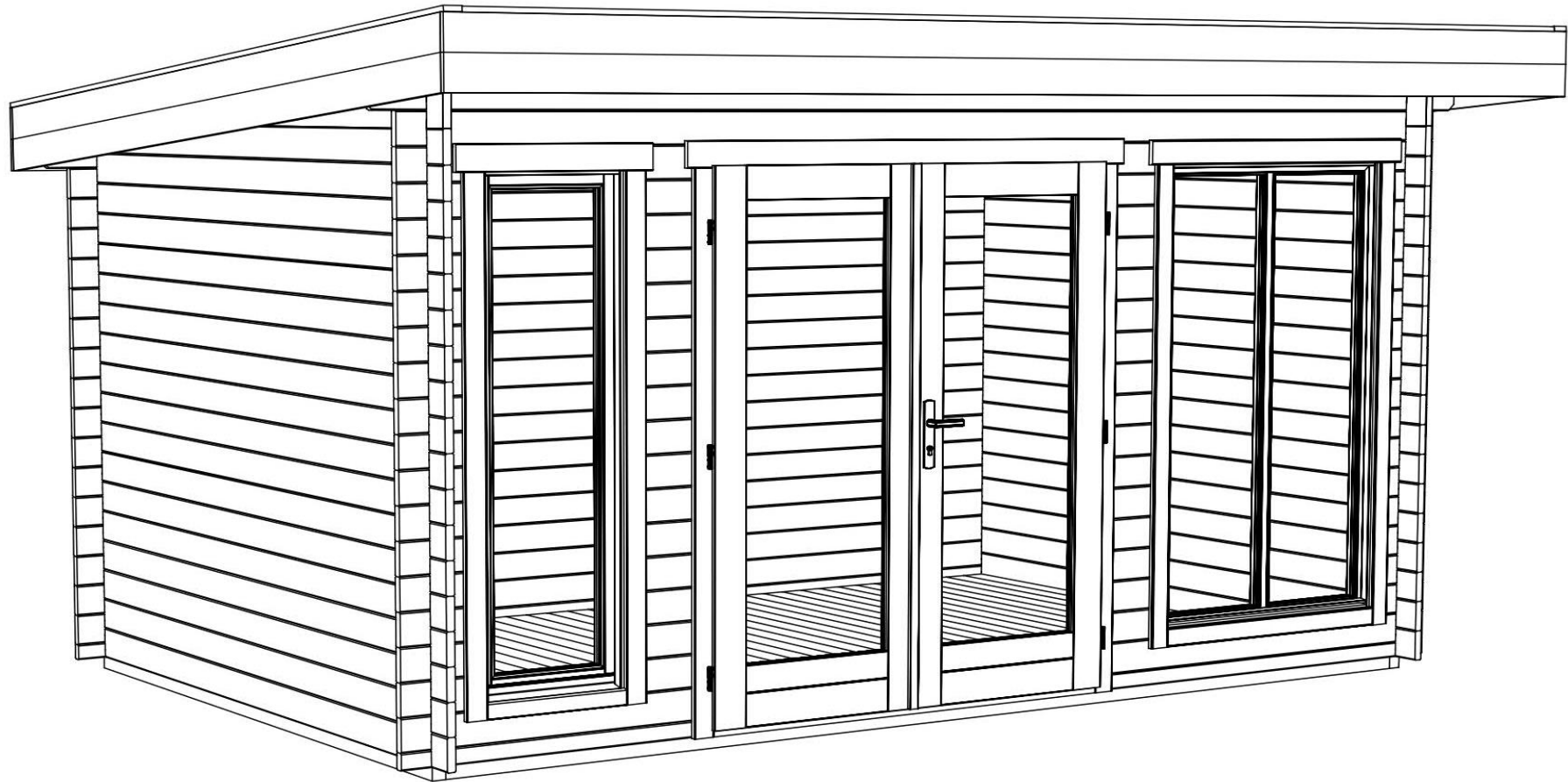

20.03.2020

Groundplan - Grundplan - Plan de masse -  
Planimetria - Plattegrond - Põhiplaan

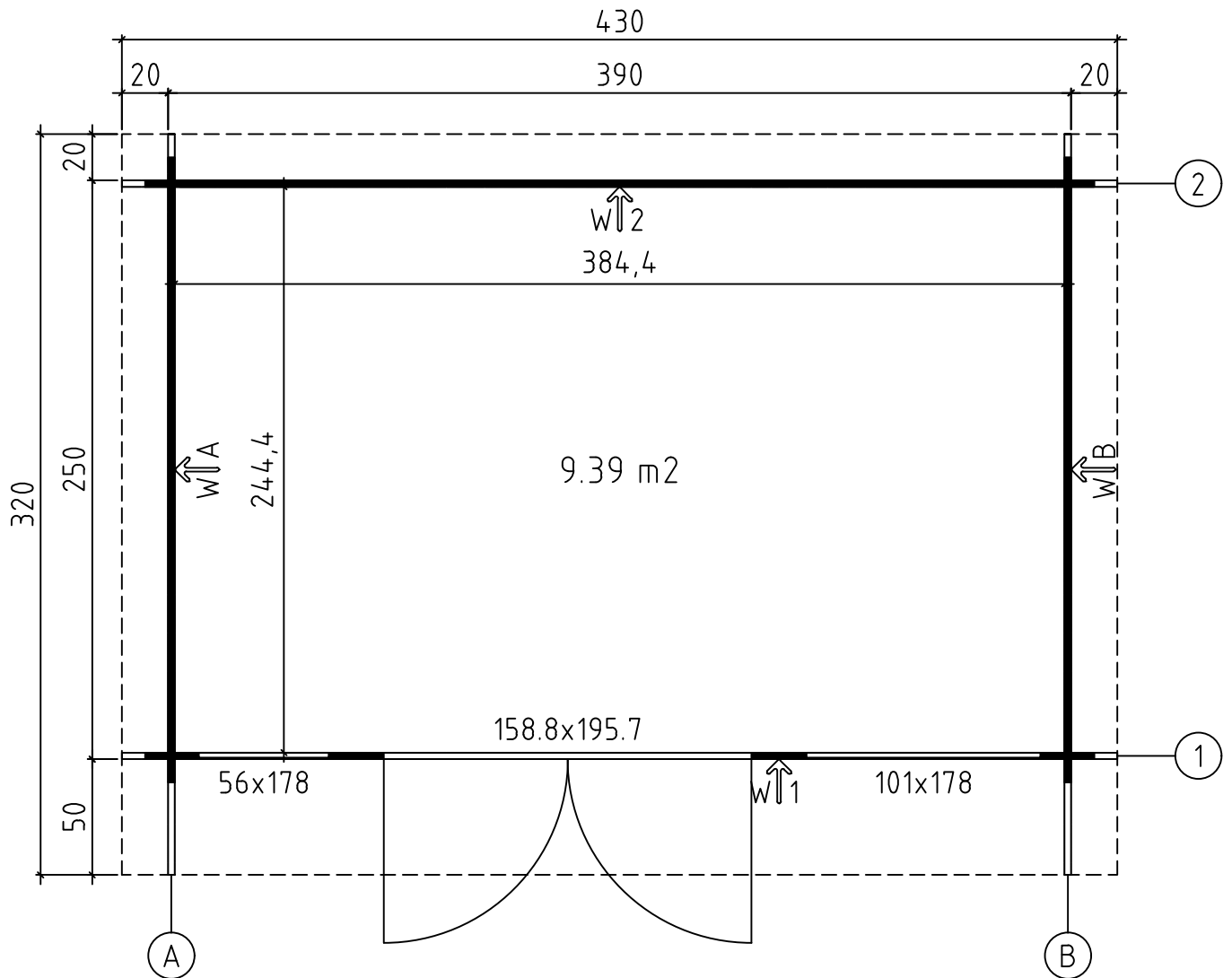

Foundation - Fundament - Fondation  
Fundamenta - Fundering - Immutatud alusraam

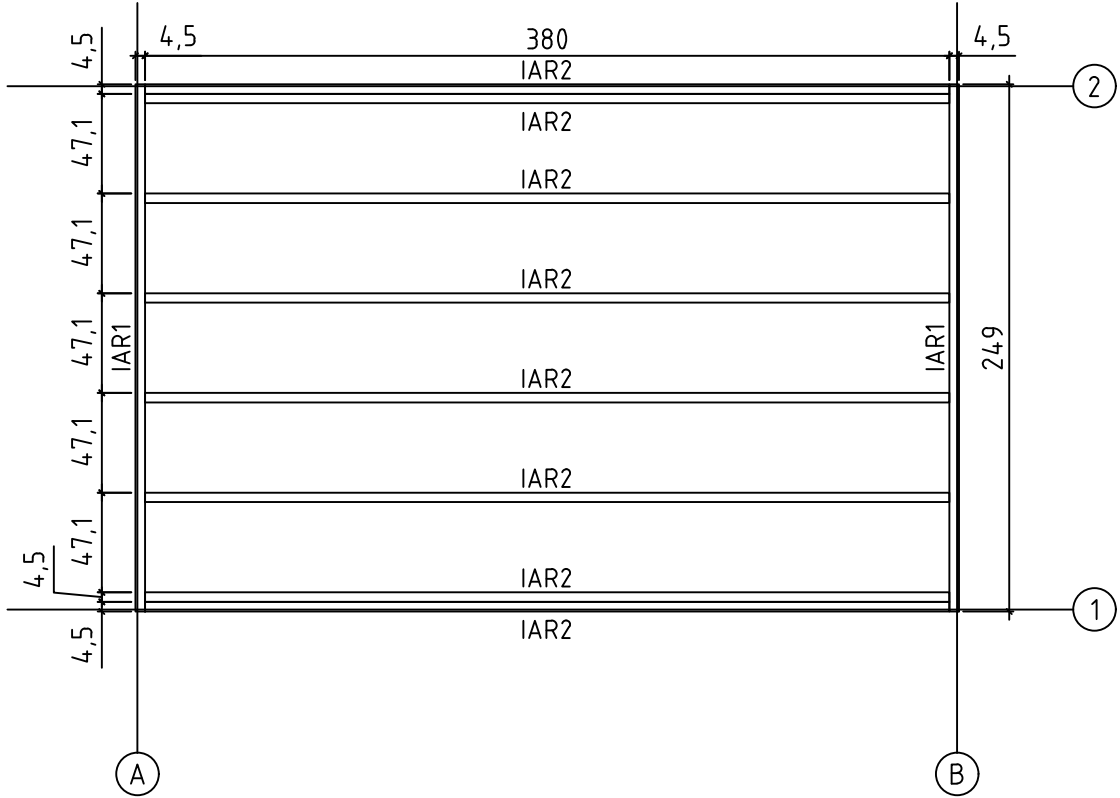



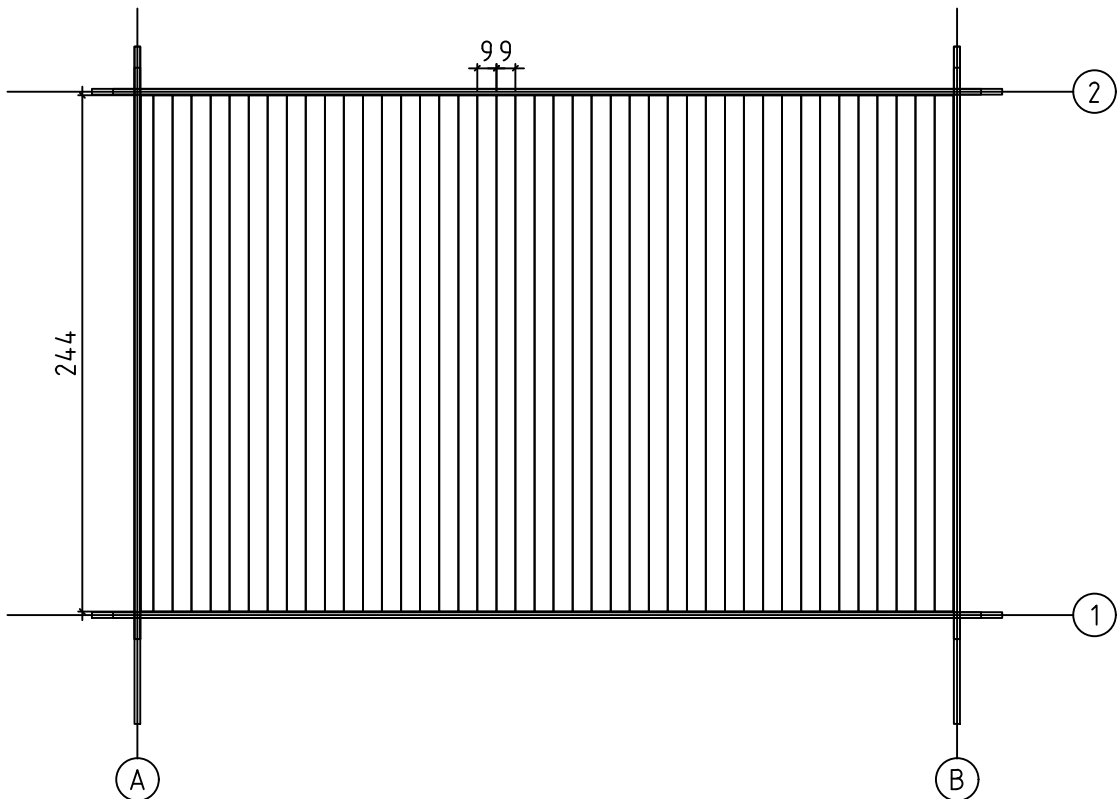





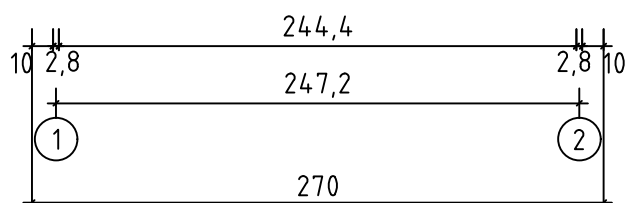
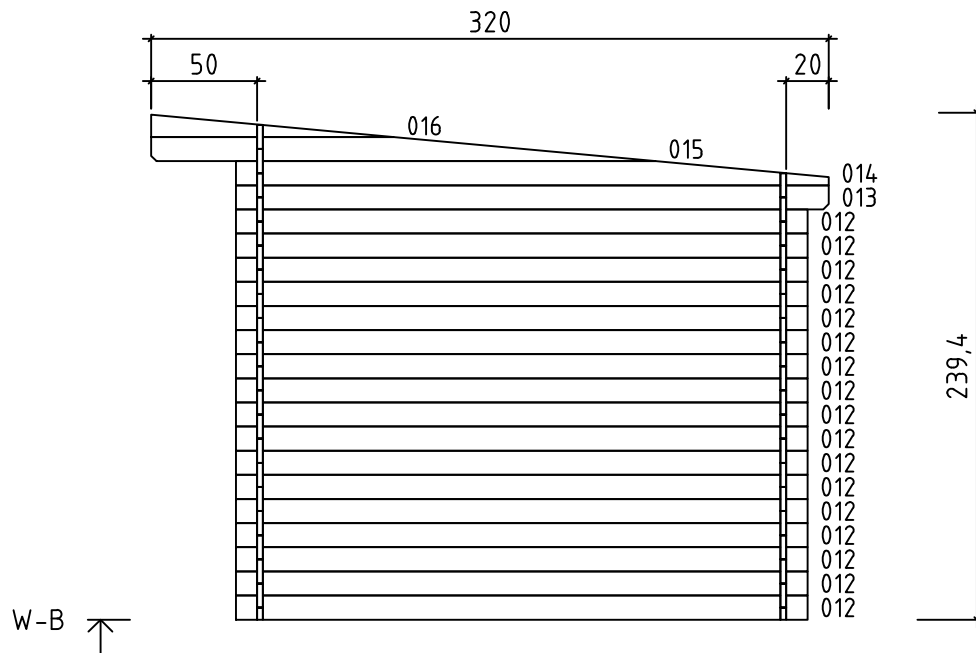
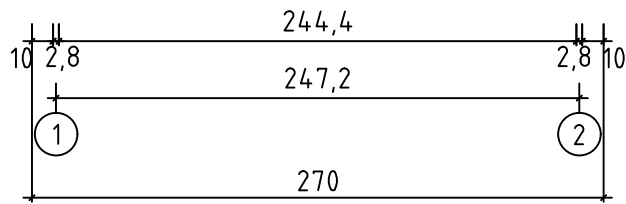
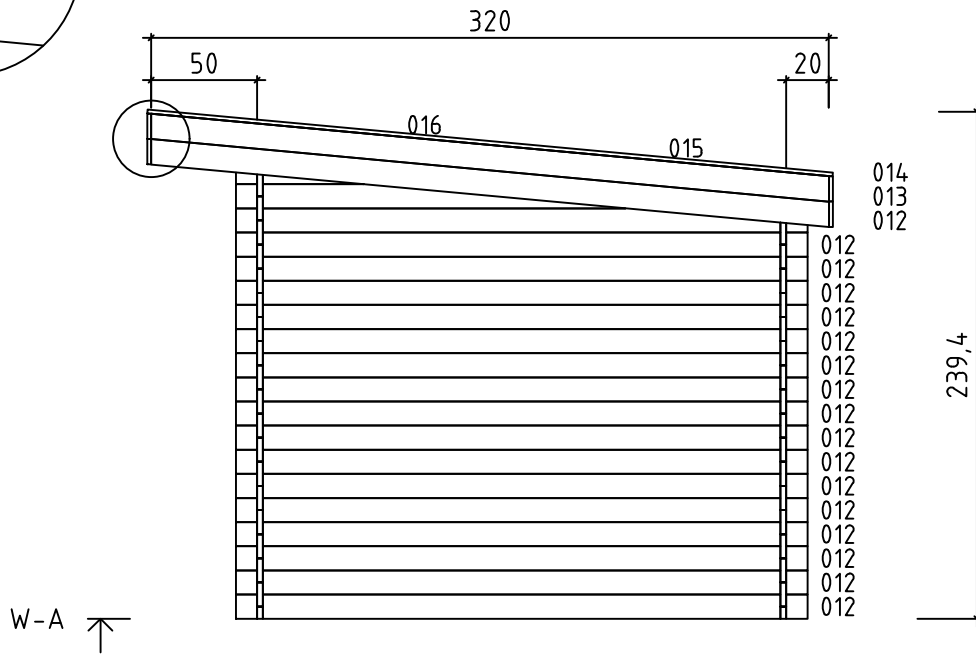
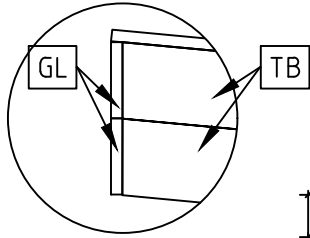

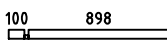
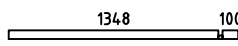
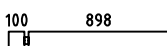
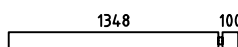
Floor boards - Fussbodenbretter - Plan pose plancher - Pavimento -  
Vloerhout - Põrandalaudis

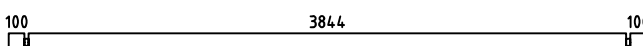
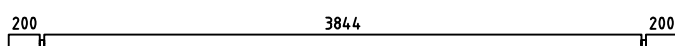
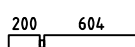
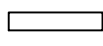
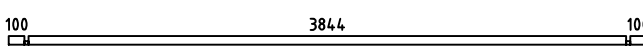
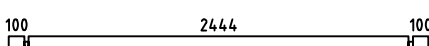
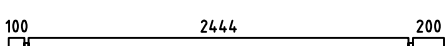
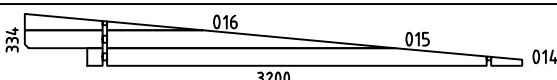
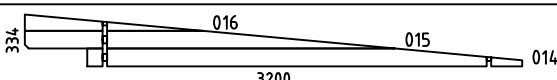

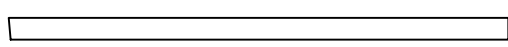







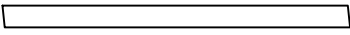



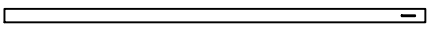
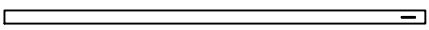
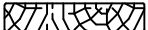
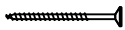
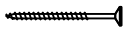

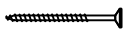



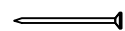

Art. Nr. 2848702

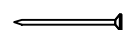

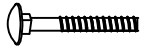
Pos	20.03.2020 Piece list - Stückliste - Liste des pièces - Elementi - Stuklijst - Tükítabel Art. Nr. 2848702 6/8	Q	P (mm)	L (mm)
001		1	28x57	1026
002		1	28x57	1476
003		1	28x114	1026
004		1	28x114	1476
005		32	28x114	228
006		32	28x114	228
007		17	28x114	4100
008		2	28x114	4300
009		4	28x114	832
010		8	28x114	604
011		1	28x57	4100
012		34	28x114	2700
013		2	28x114	2800
WA-1		1		
WB-1		1		
IAR2	Foundation - Fundament - Fondation - Fondamenta - Fundering - Immutatud alusraam 	8	45x45	3800
IAR1	Foundation - Fundament - Fondation - Fondamenta - Fundering - Immutatud alusraam 	2	45x45	2490
SR1	SARIKAD 	5	44x140	3214
	Floor boards - Fussbodenbretter - Lame de plancher - Pavimento - Vloerhout - Põrandalaud 	43	90x18	2440
	Roof boards - Dachbretter - Voliges - Perlina per tetto - Dakhout - Katuselaud 	36	90x18	4300
	Floor fillet - Fussbodenleiste - Corniere de finition du plancher - Finitura per pavimento (battisco pa) - Vloerafwerklijst - Põrandaliist 		18x18	13
	Roofing felt fillet - Dachpappenleiste - Baguette de fixation du feutre bitumeux - Asse per fissaggio guaina bituminosa - Afdekljst asfaltpapier - Katusepapiiist 	2	18x58	3250
	Roofing felt fillet - Dachpappenleiste - Baguette de fixation du feutre bitumeux - Asse per fissaggio guaina bituminosa - Afdekljst asfaltpapier - Katusepapiiist 	1	18x58	4220



Pos	Piece list - Stückliste - Liste des pièces - Elementi - Stuklijst - Tükitalabel 20.03.2020 Art. Nr. 2848702 7/8	Q	P (mm)	L (mm)
TB	Fascia board - Traufbrett - Bandeau de toit - Finitura lati tetto - Gevellijst - Räästalaud 	4	18x120	3227
DRV-1	Roof edge reinforcement - Dachrandverstärkung - Corniere de renfort de bord de toit - Rinforzo x tetto - Dakrand versterking - Räästatugevdus 	2	28x34	200
DRV-2	Roof edge reinforcement - Dachrandverstärkung - Corniere de renfort de bord de toit - Rinforzo x tetto - Dakrand versterking - Räästatugevdus 	2	28x34	500
DRV-3	Roof edge reinforcement - Dachrandverstärkung - Corniere de renfort de bord de toit - Rinforzo x tetto - Dakrand versterking - Räästatugevdus 	2	28x34	2444
KFS-1	Storm protection - Sturmleiste - Latte anti-tempete - Protezione anti vento - Stormverankering / beveliging - Tormikinnitusliist 	2	22x45	2050
KFS-2	Storm protection - Sturmleiste - Latte anti-tempete - Protezione anti vento - Stormverankering / beveliging - Tormikinnitusliist 	2	22x45	2500
GL	Gable moulding - Giebelleiste - Planche de rive - Finitura per frontale e retro del tetto - Gevellijst - Viilulaud 	4	18x120	4336
HS9	Screw for gable moulding - Schrauben für giebelleiste - Vis pour fixation planche de rive - Vite per fissare finiture davanti e dietro del tetto - Schroef voor gevellijst - Kruvi viilulauale 	42	3.5x50	
HS12	Screw for fascia boards - Schrauben für traufbretter - Vis pour fixation bandeau de toit - Viti x striscia del tetto - Schroef voor gevellijst - Kruvi räästalauale 	32	4x40	
HS12	Screw for roof edge reinforcement - Schrauben für dachrandverstärkung - Vis pour fixation corniere renfort de bord de toit - Viti x rinforzo bordo tetto - Schroef voor dakrand versterking - Kruvi räästatugevdusele 	14	4x40	
HS18	Screw for rafter - Schrauben für dachsparren - Vis pour chevron - Vite per trave - Schroef voor dakspar - Kruvi sarikatele 	10	5x120	
HS18	Screw for gable - Schrauben für giebel - Vis pour fixation des pignons - Viti per timpano - Schroef voor gevelpunt - Kruvi viilude kinnitamiseks 	4	5x120	
HS16	Screw for foundation - Schrauben zur befestigung fundament - Vis de fixations des poutrelles de fondations - Viti x fondamenta - Schroef voor fundering - Kruvi alusraamile 	20	5x90	
HS23	Screw for wall details - Schraube für wand details - Vis pour mur details - Viti per elementi della porta - Schroef voor wand details - Kruvi seinadetailidele 	24	6x180	
NF2	Zn nail for floor fillet - Zn nagel für fussbodenleiste - Pointe pour corniere de finition du plancher - Chiodi x fissaggio pavimento - Spijker(nagel) voor vloer afdekljst - Nael põrandaliistule 	26	1.4x40	
SH28	Hammer block - Schlagholz - Calle de frappe - Blocco di legno da usare come cuscinetto quando si usa il martello - Slagklos - Löögiklots 	1		
SFS	Nut for storm protection - Schraubenmutter für sturmleiste - Erou pour latte anti-tempete - Dado x asta protezione vento - Moer voor stormverankering - Mutter tormikinnitusliistule 	8	D6	
NF4	Zn nail for roof - Zn nagel für dachbretter - Pointe pour fixation voliges de toit - Chiodi x perline tetto - Spijker(nagel) voor dakhout - Nael katuselauale 	271	2x50	
NF4	Zn nail for floor - Zn nagel für fussbodenbretter - Clous pour plancher - Chiodi x perline pavimento - Spijker(nagel) voor vloer - Nael põrandalauale 	264	2x50	
NF5	Zn nail for roofing felt fillet - Zn nagel für dachpappenleiste - Pointe pour baguette de fixation feutre bitumeux - Chiodi x carta bituminosa x tetto - Spijker(nagel) voor asfaltpapier afdekljst - Papiliistunael 	26	2x40	
BFS	Bolt for storm protection - Bolzen für sturmleiste - Boulon pour latte anti-tempete - Bullone x asta protezione vento - Bout voor stormankerlat - Puidupolt tormikinnitusliistule 	8	6x60	
DFS	Washer for storm protection - Dichtscheibe für sturmleiste - Rondelle pour latte anti-tempete - Rondella x asta protezione vento - Afdichtring voor storm strip - Seib tormikinnitusliistule 	8	D6	
	Window - Fenster - Fenetre - Finestra - Raam - Aken 560x1780 AK.1.100.PSP DGC	1		



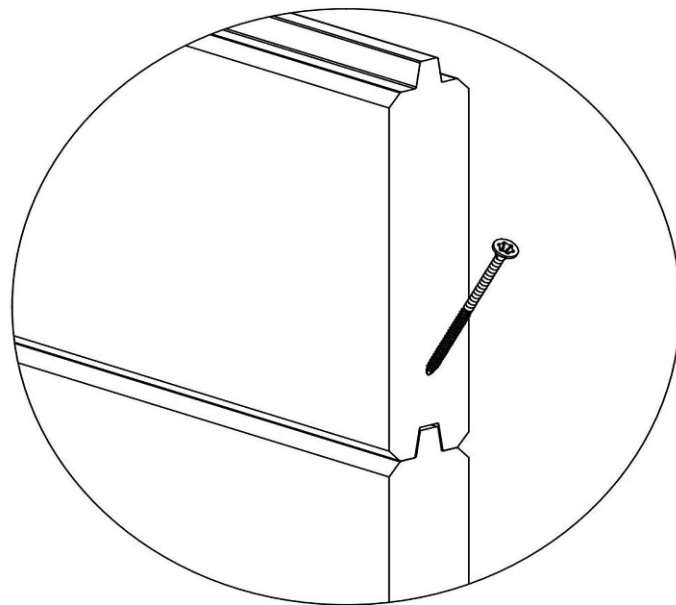
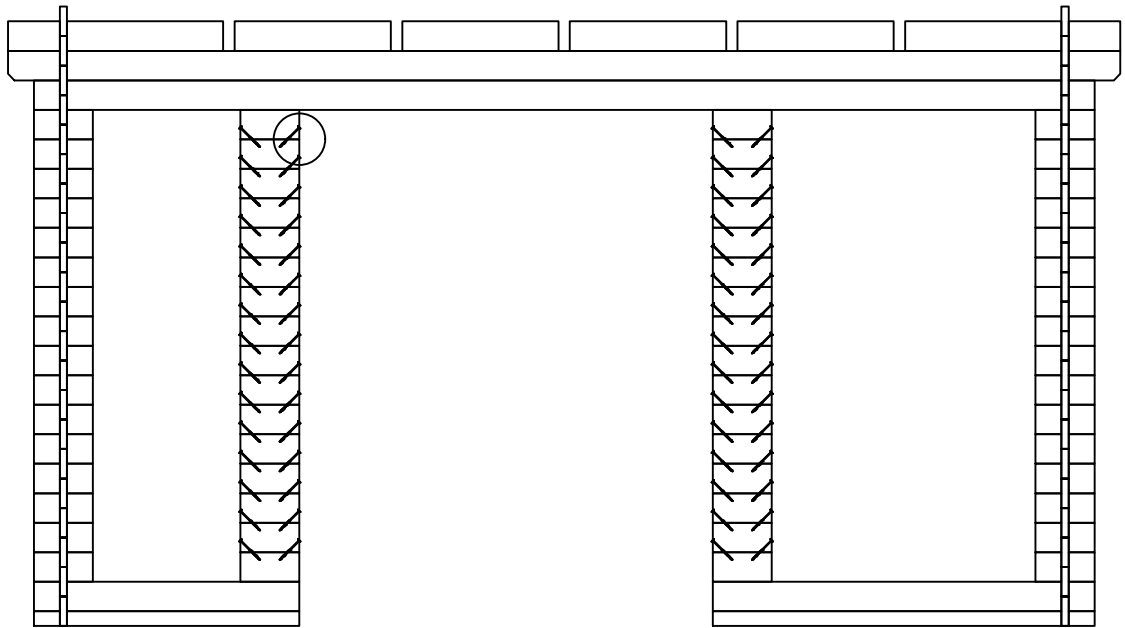

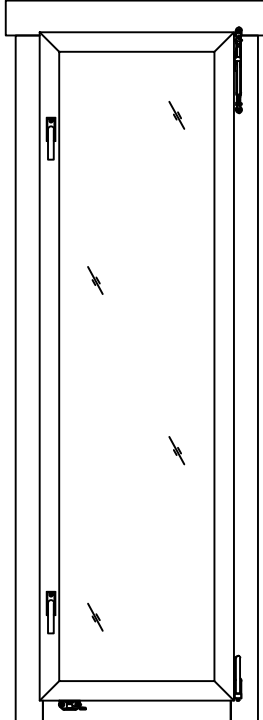
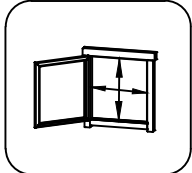

To ensure better stability of your cabin, we recommend that the logs without tenon ( $\leq 40$  cm) are connected together with screws (3,5x80mm). Screws are not included in the assembly set.

Pos	14.09.2015 Piece list - Stückliste - Liste des pièces - Elementi - Stuklijst - Tükítabel 560x1780 AK.1.100.PSP DGC	1/1	Q	P (mm)	L (mm)
	<p data-bbox="263 152 1292 183">Glass size - Glasgröße - Taille de la vitre - Misura del vetro - Glas afmeting - Klaasi mõõt: 416x1636 mm</p>   <p data-bbox="1364 347 1492 376">460x1680 mm</p>				
FS1	<p data-bbox="263 2038 1021 2094">Window handle fittings - Fenstergriff - Poignee de fenetre - Maniglia c/ferramenta - Raamhendel -/grendel -/klink - Aknalink</p>		2		
FSP	<p data-bbox="263 2116 1101 2195">Bolt for window handle fittings - Bolzen für fenstergriff beschlag - Vis pour fixation poignee de fenetre - Bullone x apertura manuale finestra - Schroef voor raamhendel - Akna käepideme polt</p>		4		

Pos

14.09.2015 Piece list - Stückliste - Liste des pièces - Elementi - Stuklijst - Tükítabel  
1010x1780 TAK.1.100.PM0.e DGC

1/1





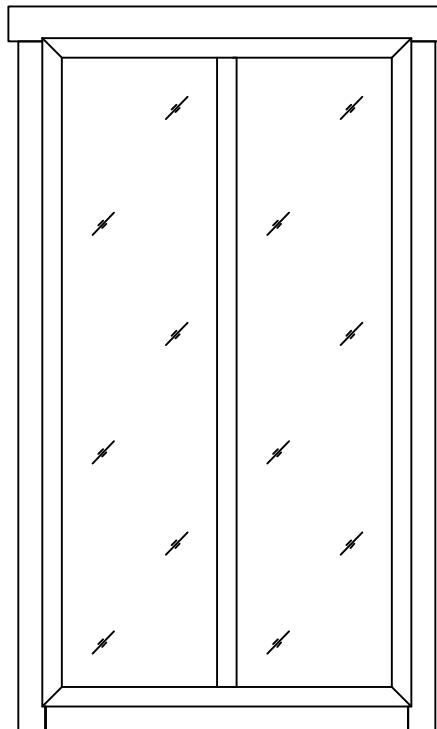

Q

P  
(mm)

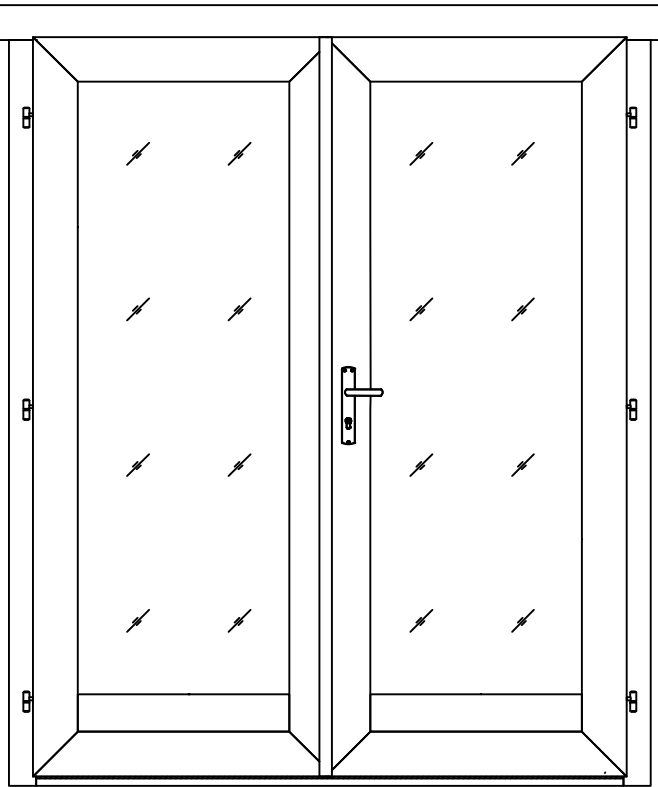
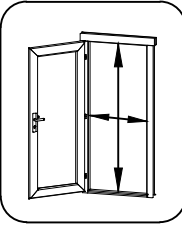
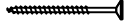
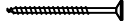
L  
(mm)

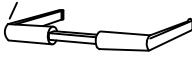
Glass size - Glasgröße - Taille de la vitre - Misura del vetro - Glas afmeting - Klaasi mõõt: 416x1636 mm

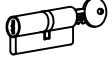
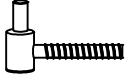

Pos	20.03.2020	Piece list - Stückliste - Liste des pièces - Elementi - Stuklijst - Tükitalabel 1588x1957 TUK.1.100.PVP.MM DGC	1/1	Q	P (mm)	L (mm)
		Glass size - Glasgröße - Taille de la vitre - Misura del vetro - Glas afmeting - Klaasi mõõt: 561x1593 mm				
						
						 1488x1875 mm
HS4	Screw for door fillet - Schraube zur Befestigung Türleiste - Vis pour fixation baguette d'arrêt de porte - Viti per massellino della porta - Schroef voor deurlijst - Krugi ukse kokkuvaltsiliistule		5	3x30		
HS16	Screw for door jamb - Schraube für Türrahmen - Vis de fixation partie haute avec montants du cadre de porte - Viti x fissaggio montanti porte - Schroef voor deurkozijn - Krugi ukse lengile		4	5x90		
HS25	Screw for doorstep - Schrauben für swelle - Vis pour fixation barre de seuil - Vite per soglia della porta - Schroef voor deurdorpel - Krugi lävepakule		3	4.5x65		
TL4	Door handle fittings - Türgriff - Poignée de porte - Maniglie - Deurhendel / klink - Ukse käepide		1			
TL5	Set of door lock covers - Schlossblenden - Set de garnitures de porte - Copertura serrature - Slot sluitplaat set - Ukse lukuplaat		1			
	Cylinder lock - Zylinderschloss - Barillet de porte - Serratura - Cylinder slot - Ukse lukusüdamik		1	30x35		
	Male bolt hinge for door - Türband - Partie male de paumelle de porte - Cerniera anube x porta - Scharnier bout - Ukse polthing isane		6			
	Striker for barrel bolt - Hülse für Grendelriegel - Gache au sol du targette - Boccola per fermo della porta - Huls voor vergrendelingsschuif - Vasturaud ukse servariivile		2			